

280363 ✓ ACTIVE

AMPMODU | AMPMODU IV/V

TE Internal #: 280363

Housing, Receptacle, Wire-to-Board, 15 Position, 2.54 mm [.1 in]
Centerline, Crimp, 1 Row, Black, Mating Retention, Wire & Cable,
Signal, AMPMODU IV/V

[View on TE.com >](#)



Connectors > PCB Connectors > Wire-to-Board Connectors > Wire-to-Board Connector Assemblies & Housings



Connector Product Type: **Housing**

Connector & Housing Type: **Receptacle**

Connector System: **Wire-to-Board**

Number of Positions: **15**

Centerline (Pitch): **2.54 mm [.1 in]**

Features

Product Type Features

Connector Product Type	Housing
Connector & Housing Type	Receptacle
Connector System	Wire-to-Board
Connector & Contact Terminates To	Wire & Cable

Configuration Features

Number of Positions	15
Number of Rows	1

Contact Features

Contact Layout	Inline
Contact Type	Socket
Contact Current Rating (Max)	3 A

Termination Features

Termination Method to Wire & Cable	Crimp
------------------------------------	-------

Mechanical Attachment

Panel Mount Feature	Without
PCB Mount Retention	Without
Mating Retention Type	Detent Latching
Mating Retention	With



Connector Mounting Type	Cable Mount (Free-Hanging)
-------------------------	----------------------------

Housing Features

Housing Entry Configuration	Both Ends Closed
Housing Material	LCP (Liquid Crystal Polymer)
Centerline (Pitch)	2.54 mm [.1 in]
Housing Color	Black

Dimensions

Connector Length	7.1 mm
Connector Height	3.1 mm [.12 in]
Row-to-Row Spacing	2.54 mm [.1 in]

Usage Conditions

Operating Temperature Range	-40 – 80 °C [-40 – 176 °F]
-----------------------------	----------------------------

Operation/Application

Circuit Application	Signal
---------------------	--------

Industry Standards

Glow Wire Rating	Standard Part - Not Glow Wire
UL Flammability Rating	UL 94V-0

Packaging Features

Packaging Quantity	1000
Packaging Method	Bag

Product Compliance

[For compliance documentation, visit the product page on TE.com>](#)

EU RoHS Directive 2011/65/EU	Compliant
EU ELV Directive 2000/53/EC	Compliant
China RoHS 2 Directive MIIT Order No 32, 2016	No Restricted Materials Above Threshold
EU REACH Regulation (EC) No. 1907/2006	Current ECHA Candidate List: JUNE 2022 (224) Candidate List Declared Against: JUNE 2022 (224) Does not contain REACH SVHC
Halogen Content	Low Halogen - Br, Cl, F, I < 900 ppm per homogenous material. Also BFR/CFR/PVC Free



Solder Process Capability

Not applicable for solder process capability

Product Compliance Disclaimer

This information is provided based on reasonable inquiry of our suppliers and represents our current actual knowledge based on the information they provided. This information is subject to change. The part numbers that TE has identified as EU RoHS compliant have a maximum concentration of 0.1% by weight in homogenous materials for lead, hexavalent chromium, mercury, PBB, PBDE, DBP, BBP, DEHP, DIBP, and 0.01% for cadmium, or qualify for an exemption to these limits as defined in the Annexes of Directive 2011/65/EU (RoHS2). Finished electrical and electronic equipment products will be CE marked as required by Directive 2011/65/EU. Components may not be CE marked. Additionally, the part numbers that TE has identified as EU ELV compliant have a maximum concentration of 0.1% by weight in homogenous materials for lead, hexavalent chromium, and mercury, and 0.01% for cadmium, or qualify for an exemption to these limits as defined in the Annexes of Directive 2000/53/EC (ELV). Regarding the REACH Regulation, the information TE provides on SVHC in articles for this part number is based on the latest European Chemicals Agency (ECHA) 'Guidance on requirements for substances in articles' posted at this URL: <https://echa.europa.eu/guidance-documents/guidance-on-reach>

Compatible Parts

 <p>TE Part # 87077-2 MOD IV KEYING PLUG</p>	 <p>TE Part # 181270-1 AMP-MODU CONTACT</p>	 <p>TE Part # 181270-2 MOD II CONTACT L.P.</p>	 <p>TE Part # 181270-3 MOD 2 BUCHSE</p>
 <p>TE Part # 280530-4 MOD2 BUCHSE</p>	 <p>TE Part # 280530-2 AMP MODU MOD 2 CONT</p>	 <p>TE Part # 281556-2 20AWG MOD 2 CRIMP TIN PLATE</p>	 <p>TE Part # 280530-1 MOD II COSI RECP CONT STR PH-B</p>
 <p>TE Part # 280708-2 MOD 2 CONTACT</p>	 <p>TE Part # 280375-2 15P AMPMODU II SHRD HDR, ST, 0.38 AU</p>	 <p>TE Part # 280530-3 MOD II COSI RECP CONT STR PRE</p>	 <p>TE Part # 182207-2 AMP MODU II RCPT CONT COSI LP</p>



TE Part # 280375-1
15P AMPMODU II SHRD HDR, ST, TIN

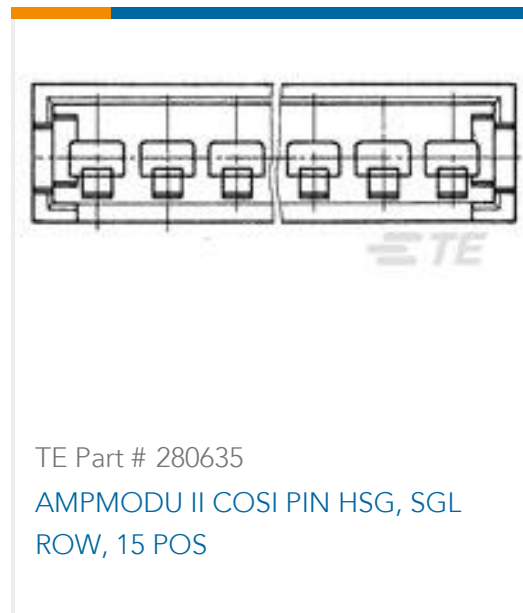

TE Part # 280635
AMPMODU II COSI PIN HSG, SGL ROW, 15 POS



TE Part # 182206-2
MOD 2 TERMINAL



TE Part # 181271-2
MOD 2 CONTACT REC.

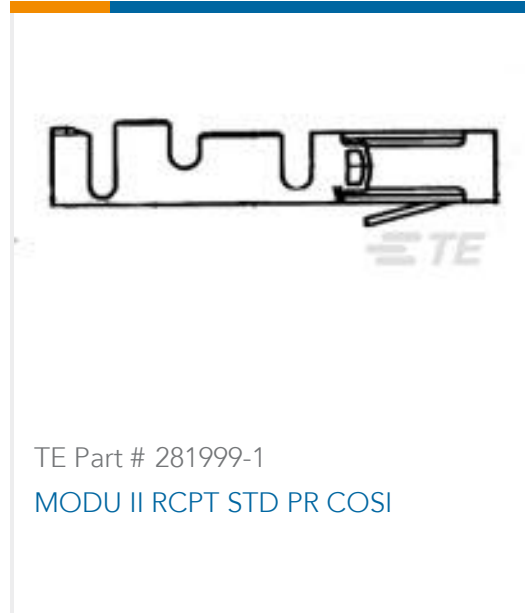

TE Part # 281999-1
MODU II RCPT STD PR COSI



TE Part # 280382-1
15P MODU II SHRD HDR, RT ANG, TIN

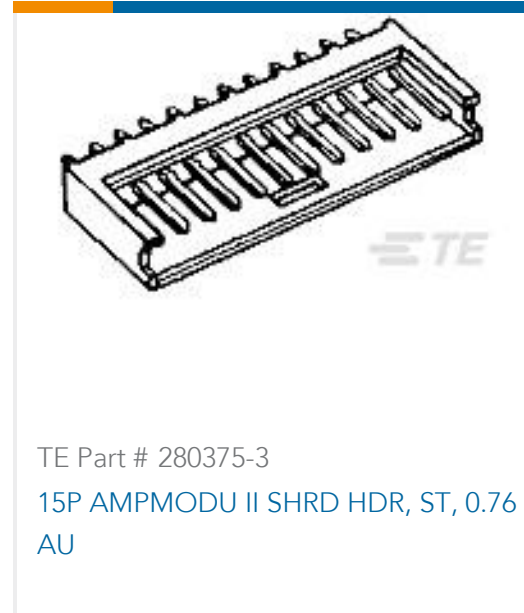

TE Part # 280375-3
15P AMPMODU II SHRD HDR, ST, 0.76 AU



TE Part # 280382-2
15P MODU II SHRD HDR, RT ANG, 0.38 AU

Also in the Series | AMPMODU IV/V

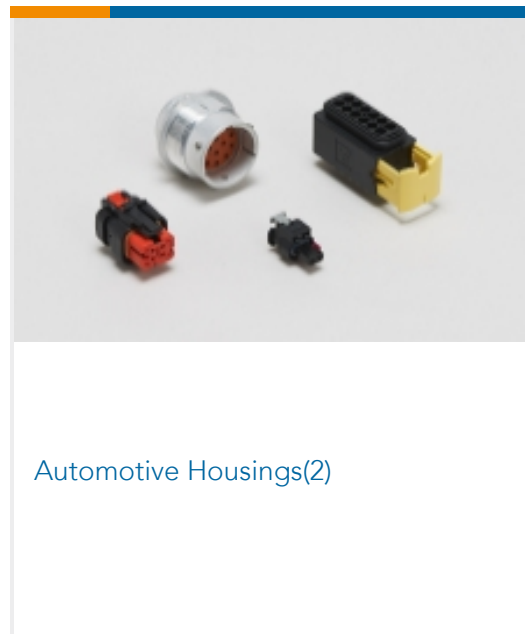

Automotive Housings(2)

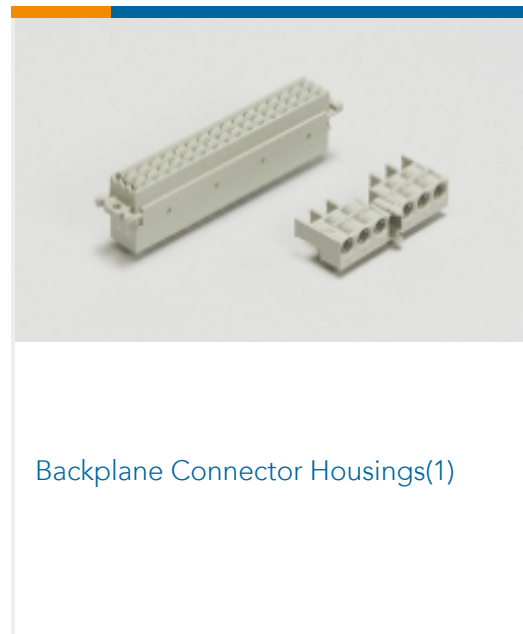

Backplane Connector Housings(1)

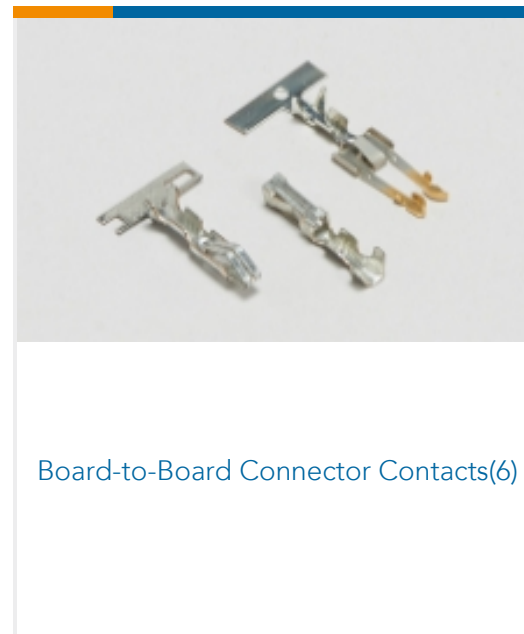

Board-to-Board Connector Contacts(6)

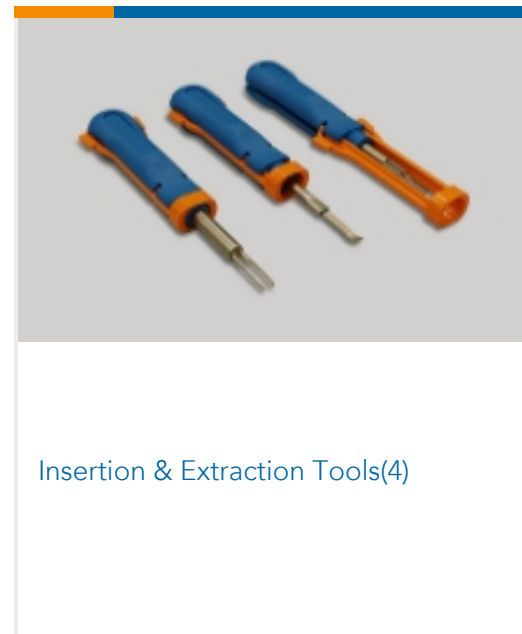

Insertion & Extraction Tools(4)



PCB Connector Covers(18)

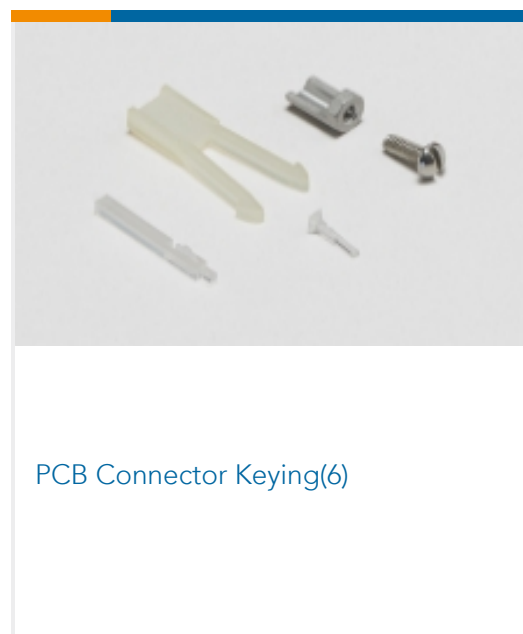

PCB Connector Keying(6)



PCB Connector Mounting(1)



PCB Connector Strain Relief(3)



PCB Headers & Receptacles(939)

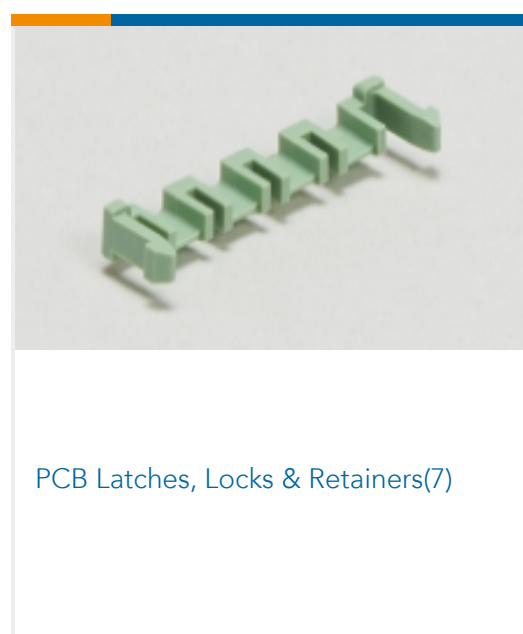

PCB Latches, Locks & Retainers(7)

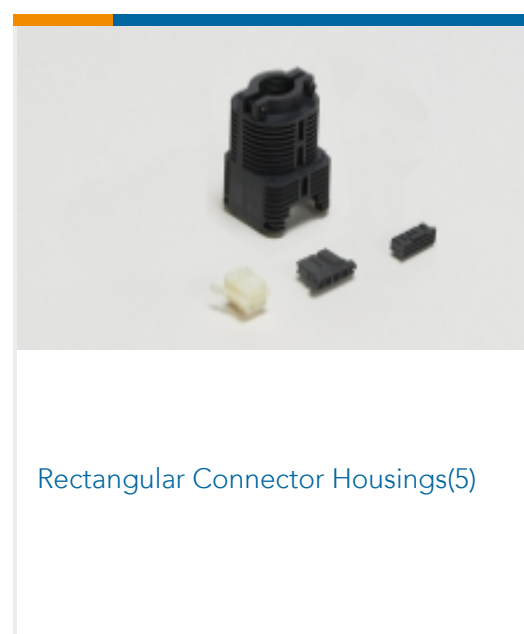

Rectangular Connector Housings(5)

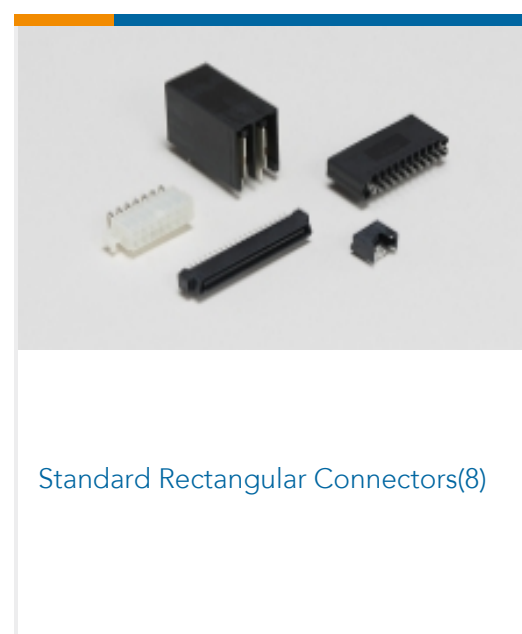

Standard Rectangular Connectors(8)



Wire-to-Board Connector Assemblies & Housings(467)



Wire-to-Board Connector Contacts (326)

Documents

CAD Files

3D PDF

3D

Customer View Model

[ENG_CVM_CVM_280363_Z.2d_dxf.zip](#)

English

Customer View Model

[ENG_CVM_CVM_280363_Z.3d_igs.zip](#)

English

Customer View Model

[ENG_CVM_CVM_280363_Z.3d_stp.zip](#)

English

By downloading the CAD file I accept and agree to the [Terms and Conditions](#) of use.

Product Environmental Compliance

TE Material Declaration

English